

Chainsaw Chains and Bars

E. Bauske, J. Fuder, and G. Rains

The action end of a chainsaw, or the part that cuts, is made of the bar and the chain. Chainsaw chains come in many sizes and configurations and not all saws can handle all bars.

A saw operator should be aware of the cutter type, pitch, gauge, and cutter configuration when purchasing a chain or a chainsaw.

A diagram of the parts of a chainsaw cutter is below.

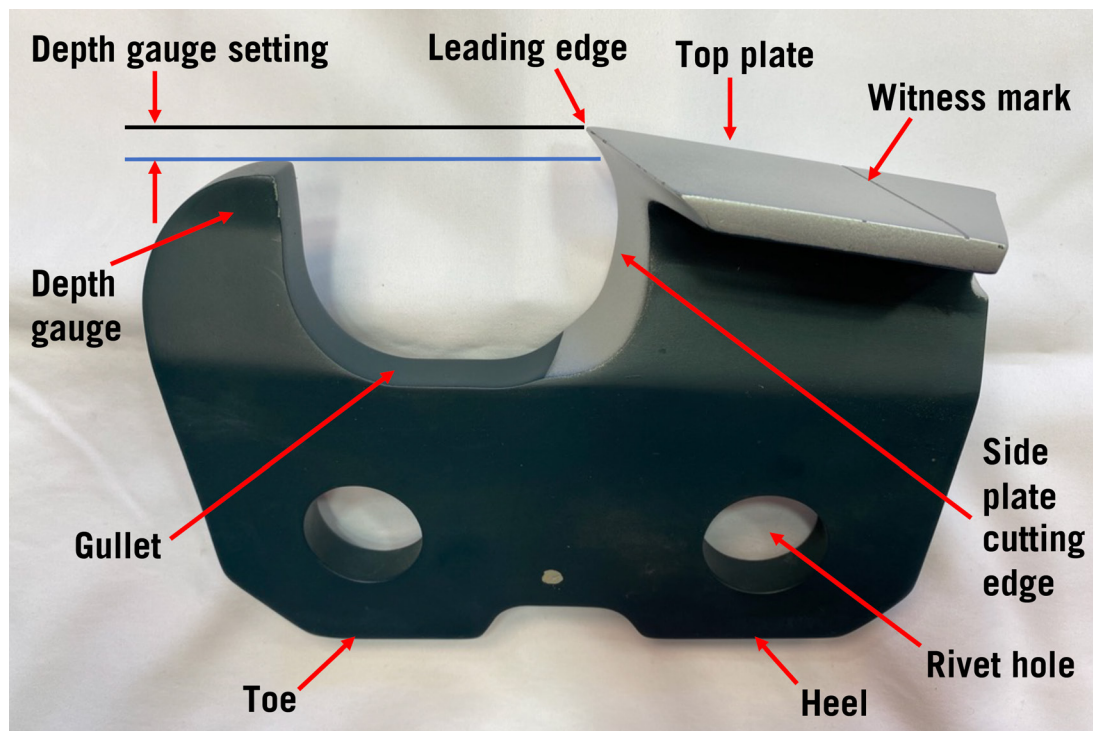

UNIVERSITY OF GEORGIA
EXTENSION

THE FOUR TYPES OF CUTTERS

Low profile

The low profile cutter is easy to sharpen and has a rounded leading edge and round side plate above the gullet. A low profile chain is lighter in weight and size, requiring less power to operate. These chains are often found on saws with engine sizes up to 42 cubic centimeters (cc) and are commonly found on saws for homeowner or arborist use.

Low profile cutters are used on low kickback chains. Drive links called bumper tie straps or bumper drive links are added between the cutters. The additional depth gauge they provide prevents the cutter from taking too big of a bite as the chain comes around the top quadrant, or kick back zone, of the bar tip. These chains cut less aggressively and bore cuts go very slowly if at all.

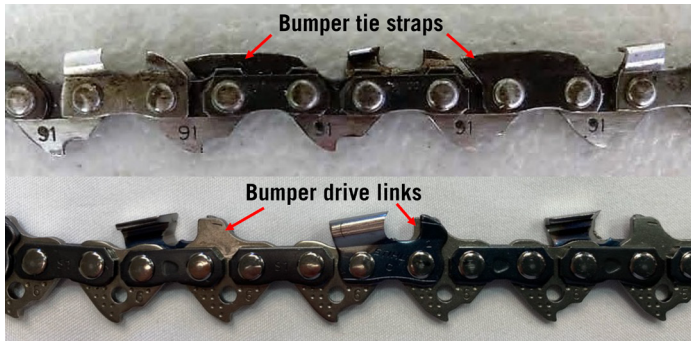
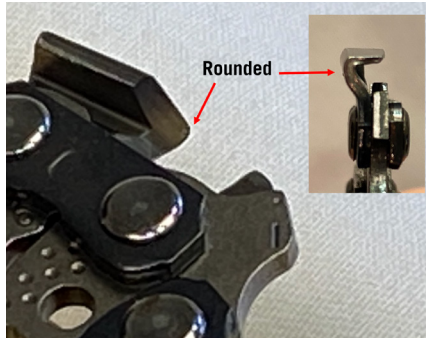

Semi-chisel

Semi-chisel cutters also have a round leading edge and round side plate above the gullet. The semi-chisel cuts slower than the chisel chain, stays sharper longer in abrasive cutting (dirty wood) conditions, and is simple to file or grind. These cutters are a sound choice for firewood cutting.



Chisel

Chisel cutters have a flat top with a chiseled leading edge that creates a deeper and wider kerf (cut) than the rounded edge or the semi-chisel cutter. The side cutting plate is rounded. The chisel cuts faster than semi-chisel, but it dulls quickly in abrasive conditions. Fortunately, it is easy to hand sharpen and any shop that professionally sharpens chains can handle it.

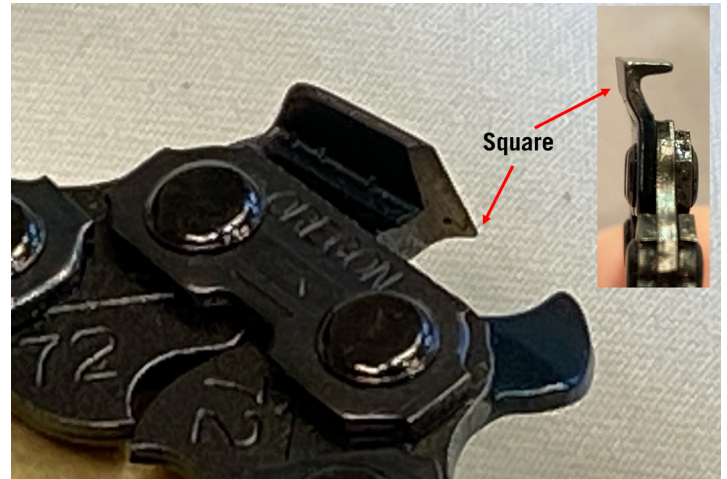

Square chisel

The square chisel cutter has the same flat top and leading edge as the chisel, but the side plate is flat-filed, creating a second chisel under the leading edge chisel. This chain is very aggressive and holds its edge well. It is often used on "big wood." It is challenging to hand-file because it requires precise corner alignment and filing angles. Most users use a grinder or take the chain to a shop for sharpening. Not all shops can sharpen it.

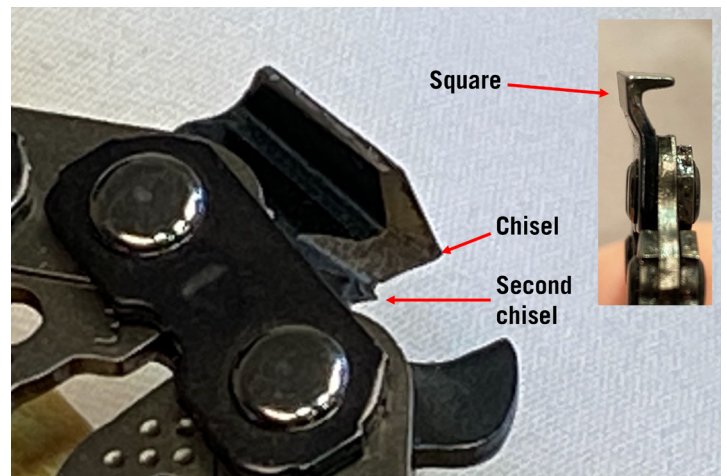

Cutter configuration

Cutters can be configured on the chain in different patterns. A full complement configuration is cutter, tie, cutter for the entire length of the chain. This is the most common configuration.

A skiptooth chain configuration is cutter, tie, tie, cutter, tie, tie. This configuration is commonly used on long bars (over 24 in.), powerful saws, and big wood. It cuts quickly and takes less time to sharpen than a full complement on a long bar.

The semi-skip configuration is a compromise between the two above: cutter, tie, tie, cutter, tie, cutter, tie, tie, and so on.



Pitch and gauge

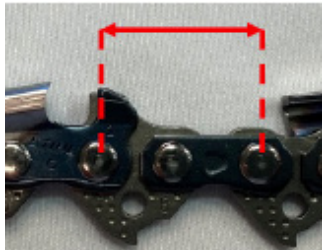

Pitch is this distance divided by two.

Two measurements, pitch and gauge, are important when purchasing or replacing a chain. Pitch is the overall size of the chain. The pitch of the chain must match the pitch of the drive sprocket and guide bar tip. Common pitch sizes are .25 in. (1/4 in.), .325 in., .375 in. (3/8 in.) and .404 in.

To determine the pitch, measure any three consecutive rivets in the saw chain from center to center in 1/16-in. increments. One-half of this measurement is the pitch.

Saw chain pitch determines the correct file size for sharpening. Not surprisingly, larger pitch chains are used on bigger saws. Use the chart below to select the right file.

Using chain pitch to select file size

Chain Pitch	File Size Standard	File Size Metric	Depth Gauge Settings
1.4"	5/32"	4.0mm	.020"-.025"
.325"	3/16"	4.5mm	.025"
3/8" (extended pitch)	3/16"	4.5mm	.020"-.025"
3/8" (low profile)	3/16"	4.5mm	.030"
3/8" (S-70)	7/32"	5.5mm	.025"
.404"	7/32"	5.5mm	.030"
7/16"	1/4"	6.0mm	.030"
1/2"	1/4"	6.0mm	.030"-.040"
9/16"	9/32"	7.0mm	.040"
2/4"	5/16"	8.0mm	.050"-.060"

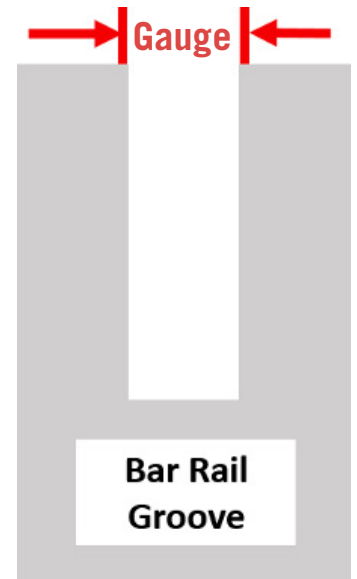

Saw pitch as it relates to chainsaw use

Chain Pitch	Description
.250" (1/4")	Designed for small chainsaw pruners and carving wood or ice
.375" (3/8") low profile	Shorter cutter profile, thinner chassis, cuts slow; for novice users
.325"	Designed for small- to medium-sized saws; cuts smoother than 3/8 in.
.375" (3/8")	Designed for medium- to large-sized saws
.404"	Designed for large saws, specialty cutting, big wood, and tough hardwoods

The gauge is the thickness of the drive link. This must match the width of the groove in the bar. Common saw chain gauge sizes are .43 in. (1.1 mm), .050 in. (1.3 mm), .058 in. (1.5 mm) and .063 in. (1.6 mm).

Fortunately, chainsaw manufacturers laser etch the chain pitch and gauge at the rear of the bar to make it easier to replace the chain to match your bar. Once the paint wears off the bar, it can be very difficult to read, so take a picture of it or write the information down and keep it with your manual.

Keep the chain sharp

If pressure must be applied to the saw to cut or the chips produced are fine and dust like, it is time to sharpen the chain. This can be done with an electric sharpener, manual file, or professional service. As previously mentioned, the pitch determines the file size for low profile, semi-chisel, and round chisel cutters.

The witness lines on the cutter will align the file when hand sharpening. The witness line also marks the limit of a chain's life. The chain must be replaced when filed to the witness line.

New chains have a break-in period. Run chainsaw two to three minutes before using. Then check the tension and adjust to the proper tension.

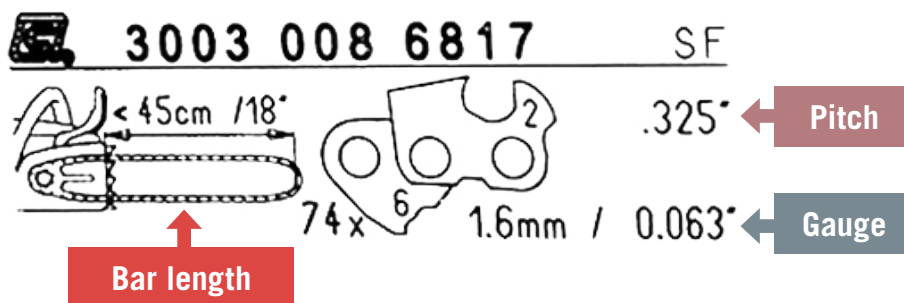

The bar

Bars range in size from 14 inches to more than 40 inches. The operator's manual will specify the bar size for the saw. It is also etched into the bar (see photo above). The length of the bar can be easily measured. Use a tape measure from the front tip all the way back to the cutter closest to the body. Round the measurement to the nearest number in inches.

The bar should be straight. This should be checked anytime the chain is off. This can be done by sighting down a long bar. Lay a bar of any length down on a flat surface and look for light underneath it. If the bar is curved, it is time to replace it.

Check both sides of the bar edges for burrs. File off any burrs. Clean the rails out with the bar cleaning tool. Make sure the oil hole at the base of the bar is clear and clean so that the movement of bar oil is not obstructed.

Check the sprocket teeth for wear. If the bar has a hole for grease, clean debris out of the hole and then apply new grease. Turn the sprocket heads to distribute the new grease. Each time the chain is sharpened, flip the bar over to even the wear on both sides of the bar.

If the chain wiggles side-to-side when properly tightened on the bar, it is time to get a new bar.



extension.uga.edu